

CEASE FIRE®

THE LEADER IN PRE-ENGINEERED FIRE SUPPRESSION TECHNOLOGY

A unique line of patented,
dual-agent overhead fire
extinguishers.



ADVANTAGES OF CEASE FIRE'S TOTAL FLOODING SYSTEM

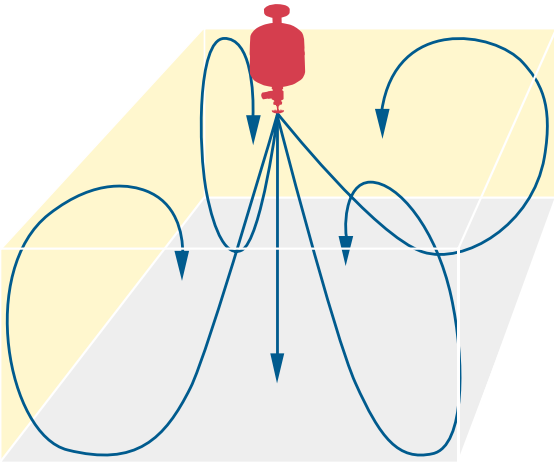

Cease Fire's Modular Flooding System

- Piping is unnecessary
- Minimal calculation for selection of product
- Simple installation process
- Increased protection

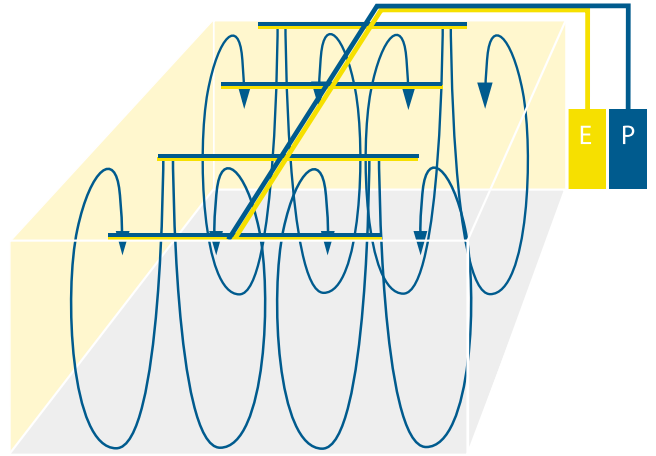

Competitor's Flooding System

- Piping is required
- Electrical wiring is required
- Installation process is complex
- System is not mobile

THE CONFIDENCE OF FM APPROVAL

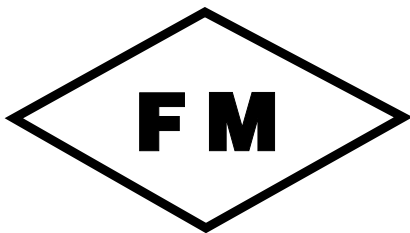

APPROVED

For more than 160 years, Factory Mutual has been a leader in property loss prevention testing and standards. At its 1,500 acre test center, FM provides real-world testing of a wide variety of fire protection products. FM standards are recognized in over 40 countries. FM-approved products like Cease Fire's CFF units offer owners confidence in the product's effectiveness and reliability.

Western Fire Center tested.

In addition, Cease Fire's products have been fully tested by Western Fire Center, an accredited test center with the International Conference of Building Officials Evaluation Service.



- For use in A, B, and C class fires

Dual-agent technology

- Cease Fire combines its unique ABC powder with DuPont's FE-227™ EPA-approved, fire extinguishing clean agent to create a dual-agent gel that provides more efficient fire suppression
- Non-toxic to occupants and environment; EPA-approved agents

Pre-installed pressure switch

- A single Cease Fire unit can protect up to 768 cubic feet

Viking Corp sprinkler head

- Simple clean up – after extinguishment, agents revert to non-toxic gas and powder



Truly modular

- Units are pre-engineered, self-contained, and automatic (heat-activated)
- No electrical installation necessary – operates in the event of a power outage

Pre-engineered

- No piping required – installation is easy
- Manual pull stations and signaling equipment can be added

45° look down pressure gauge

- Cease Fire technology enables units to be significantly smaller and lighter than comparable systems

Heat activated

- This totally unique technology provides you with the most efficient total flooding fire suppression

A partial list of applications for Cease Fire dual-agent technology...

• Computer rooms	• Specialty hazard
• Telecommunications areas	• Enclosed hazard areas
• Power or electrical areas	• Temporary construction sites
• Areas that require gentle, but powerful protection, such as museums or data and record storage	

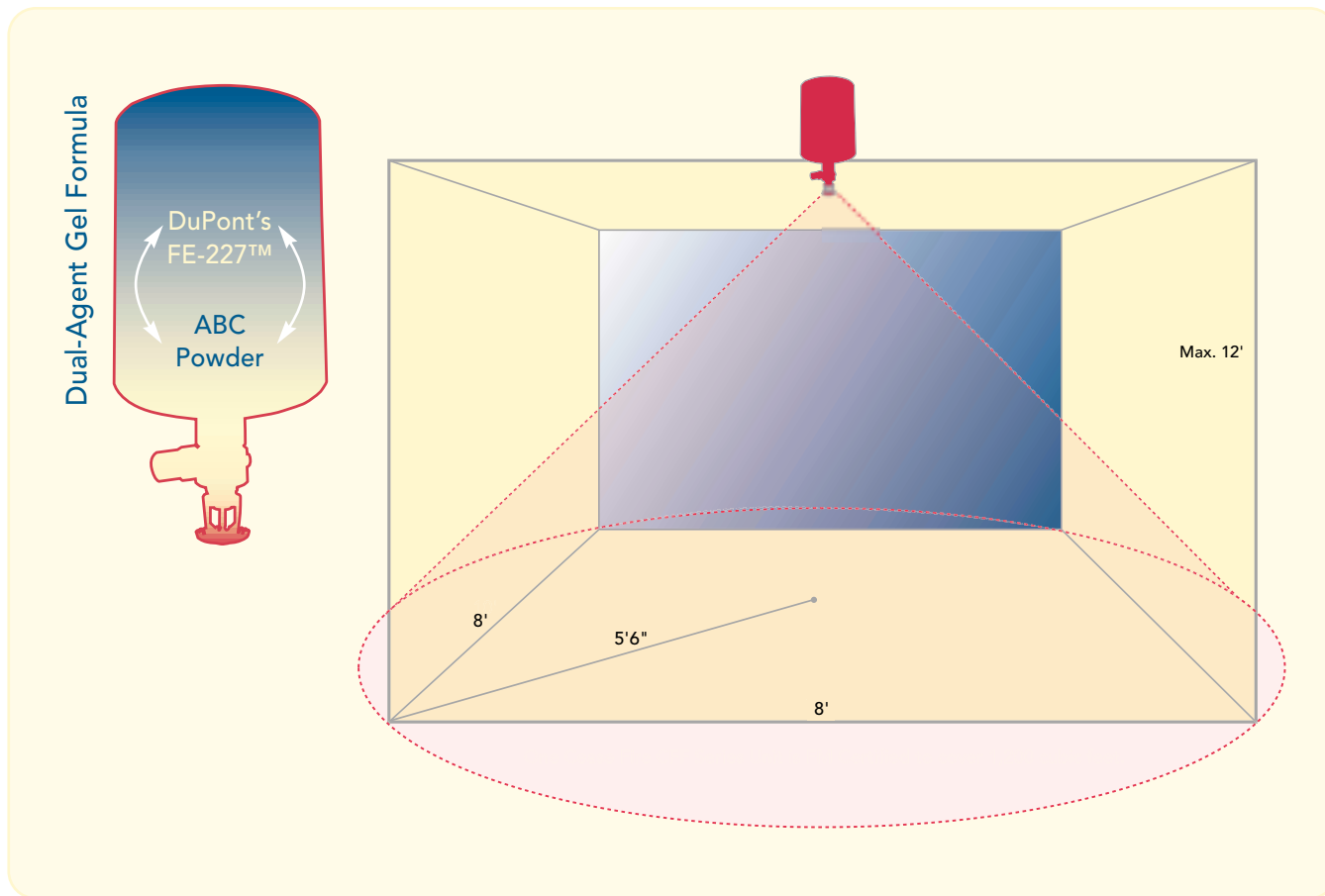

■ **Effective protection – FM approved.**

Recognized in over 40 countries, Factory Mutual (FM) Research sets the standards for effectiveness and reliability. Each Cease Fire CFF unit is fully approved by FM for total flooding protection. Each FM-approved Cease Fire unit provides local application protection in a 5 1/2 foot radius area. This means a single unit can protect an 8' x 8' room with ceilings up to 12 feet – or approximately 768 cubic feet of space. For total flooding protection, the units can be networked together.

■ **Network for total flooding solutions.**

Cease Fire units are also extremely effective for total flooding systems in larger areas. These self-contained, pre-engineered units can be easily networked to provide cost-effective protection – something competitive products can't do. The diagram below offers just one example of how several units can be linked to provide superior protection in a larger space. Most important, as your company's needs change, the modular Cease Fire units can be reconfigured with minimal expense and disruption to your business.

■ **Patented, dual-agent technology.**

Fast fire suppression and no water damage. Cease Fire's proprietary CFF technology combines the extinguishing power of two highly effective agents for faster suppression and greater coverage – in other words, more protection for your money. In fact, at a fraction of the price of piped systems, Cease Fire offers one of the most cost-effective suppression solutions available. Rated for A, B, and C class fires, Cease Fire's CFF product is appropriate for all applications where water just isn't an option.

■ **Pre-engineered, modular flexibility.**

Cease Fire's powerful, patented dual-agent formula is delivered in the industry's only true, modular system. Each unit is completely self-contained and pre-engineered. Electrical connections are unnecessary, no piping is required, and the units can be easily moved if needs change. Cease Fire units also offer activation at a variety of temperatures. With Cease Fire, service is easier, too. The unit being serviced can simply be removed – without disrupting the entire system.

Cease Fire's proprietary, dual-agent, FM-approved units can be networked to provide a total flooding system solution – at a fraction of the cost of piped systems. When two or more units are networked, the extinguishing power increases to a 10' X 10' area. In this example, four CFF units are networked to protect a 20' x 20' room with a 12' ceiling.

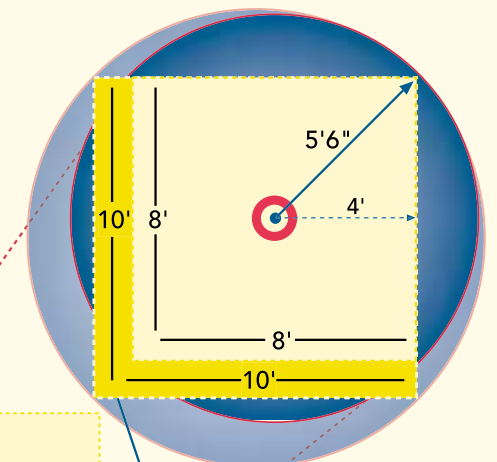
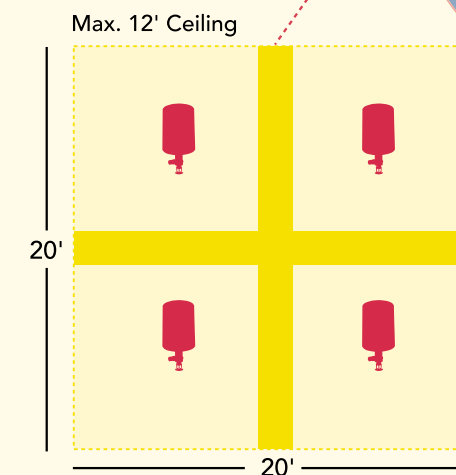

Networking Units Increases Per Unit Effectiveness
 1 CFF Unit = 768 ft³
 1 Networked CFF Unit = 1,200 ft³

ABOUT CEASE FIRE LLC

Marketplace impact.

Over 25,000 automatic Cease Fire units and over one million portable, retail units have been sold worldwide since 1986. Fire protection is our only business. Over the years, we have gained recognition not only in our industry, but outside it as well. We are confident that Cease Fire's pre-engineered, dual-agent technology is destined to be the industry's top choice for effective, efficient fire suppression in small and medium-sized spaces.

SERVICE WHEN YOU NEED IT

Great products backed by great service.

Cease Fire is not only your source for our proprietary, pre-engineered, dual-agent technology. We can also be a key technical resource. Our engineers can assist with designs for special applications. We'll build-to-spec and do custom designs. We can also help with approvals and listings research, material lists and quotations, NFPA compliance, and installation support.

Our website offers online quotations, specs, technical drawings, and more to provide you with the information you need to gain the advantages of Cease Fire protection. You'll find us at

www.ceasefire.com

MEMBERS

National Fire Protection Association



Modular Building Institute

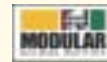

VALUED CEASE FIRE CUSTOMERS

- The London Subway
- Honeywell
- NAVISTAR Corp.
- US National Park Service
- O'Hare Airport
- Chicago Transit Authority
- LTV Steel
- Quincy Jones Broadcasting
- US Air Force/Air National Guard

CONTACT YOUR DEALER

ETA Associates

119 Foster Street, Bldg #6

Peabody, MA 01960

Tel: (978) 532-1330

Fax: (978) 532-7325

www.ETAassociates.com

eta@ETAassociates.com

